

3W Mono Class-D Audio Power Amplifier

Features

- **Operating Voltage: 2.4V-5.5V**
- **High Efficiency up to 90%**
- **Low Supply Current**
 - $I_{DD}=2mA$ at $V_{DD}=5V$
 - $I_{DD}=1.6mA$ at $V_{DD}=3.6V$
- **Low Shutdown Current**
 - $I_{DD}=1mA$ at $V_{DD}=5V$
- **Output Power**
 - at 1% THD+N**
 - 2.4W, at $V_{DD}=5V$, $R_L=4W$ (WLCSP-9)
 - 2.1W, at $V_{DD}=5V$, $R_L=4W$
 - 1.2W, at $V_{DD}=3.6V$, $R_L=4W$
 - at 10% THD+N**
 - 3.1W, at $V_{DD}=5V$, $R_L=4W$ (WLCSP-9)
 - 2.65W, at $V_{DD}=5V$, $R_L=4W$
 - 1.3W, at $V_{DD}=3.6V$, $R_L=4W$
- **Less External Components Required**
- **Fast Startup Time (4ms)**
- **High PSRR: 80 dB at 217 Hz**
- **Thermal and Over-Current Protections**
- **Space Saving Packages**
WLCSP-9 Bump
- **Lead Free and Green Devices Available**
(RoHS Compliant)

General Description

The APA2010B is a mono, filter-free Class-D audio amplifier available in WLCSP-9 packages. The gain can be set by an external input resistance. High PSRR and differential architecture provide increased immunity to noise and RF rectification. In addition to these features, a fast startup time and small package size make the APA2010B an ideal choice for both cellular handsets and PDAs. The APA2010B is capable of driving 1.5W at 5V or 730mW at 3.6V into 8Ω. It is also capable of driving 4Ω. The APA2010B is designed with a Class-D architecture and operating with highly efficiency compared with Class-AB amplifier. It's suitable for power sensitive application, such as battery powered devices. The filter-free architecture eliminates the output filter, reduces the external component count, board area, and system costs, and simplifies the design. Moreover, the APA2010B provides thermal and over-current protections.

Applications

- **Mobile Phones**
- **Handsets**
- **PDAs**
- **Portable multimedia devices**

Pin Configuration (Note 1)

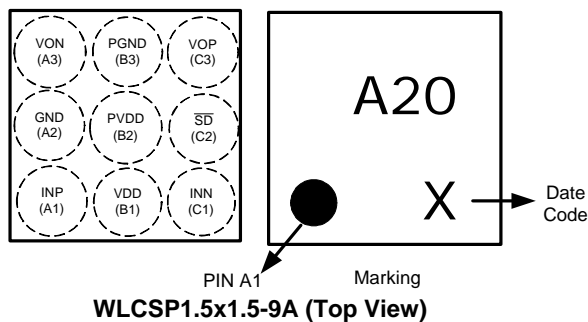

Note 1: The marking for APA2010B is "A20"

ANPEC reserves the right to make changes to improve reliability or manufacturability without notice, and advise customers to obtain the latest version of relevant information to verify before placing orders.

Ordering and Marking Information

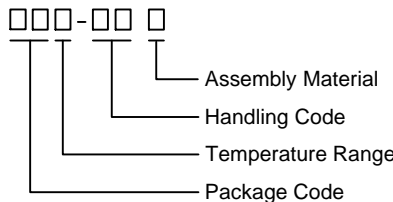
APA2010B □□□-□□ □ 	Package Code HA : WLCSP1.5x1.5-9A Operating Ambient Temperature Range I : -40 to 85 °C Handling Code TR : Tape & Reel Assembly Material G : Halogen and Lead Free Device		
APA2010B HA: <table border="1" style="display: inline-table; vertical-align: middle;"> <tr> <td style="padding: 2px;">A20</td> </tr> <tr> <td style="padding: 2px;">X</td> </tr> </table>	A20	X	X - Date Code
A20			
X			

Note : ANPEC lead-free products contain molding compounds/die attach materials and 100% matte tin plate termination finish; which are fully compliant with RoHS. ANPEC lead-free products meet or exceed the lead-free requirements of IPC/JEDEC J-STD-020D for MSL classification at lead-free peak reflow temperature. ANPEC defines "Green" to mean lead-free (RoHS compliant) and halogen free (Br or Cl does not exceed 900ppm by weight in homogeneous material and total of Br and Cl does not exceed 1500ppm by weight).

Absolute Maximum Ratings (Note 2)

(Over operating free-air temperature range unless otherwise noted.)

Symbol	Parameter	Rating	Unit
V_{DD}	Supply Voltage (VDD, PVDD)	-0.3 to 6	V
V_{IN}, V_{SD}	Input Voltage (\overline{SD} , INP, INN)	-0.3 to 6	V
T_A	Operating Ambient Temperature Range	-40 to 85	°C
T_J	Maximum Junction Temperature	150	°C
T_{STG}	Storage Temperature Range	-65 to +150	°C
T_{SDR}	Maximum Lead Soldering Temperature, 10 Seconds	260	°C
P_D	Power Dissipation	Internally Limited	W

Note2: Stresses beyond those listed under "absolute maximum ratings" may cause permanent damage to the device. These are stress ratings only and functional operation of the device at these or any other conditions beyond those indicated under "recommended operating conditions" is not implied. Exposure to absolute maximum rating conditions for extended periods may affect device reliability

Thermal Characteristics

Symbol	Parameter	Typical Value	Unit
θ_{JA}	Thermal Resistance -Junction to Ambient ^(Note 3) WLCSP1.5x1.5-9A	165	°C/W

Note 3 : Please refer to "Layout Recommendation", the ThermalPad on the bottom of the IC should soldered directly to the PCB's ThermalPad area that with several thermal vias connect to the ground plan, and the PCB is a 2-layer, 5-inch square area with 2oz copper thickness.

Recommended Operating Conditions

Symbol	Parameter	Range		Unit
		Min.	Max.	
V _{DD}	Supply Voltage	2.4	5.5	V
V _{IH}	High Level Threshold Voltage	1	-	V
V _{IL}	Low Level Threshold Voltage	-	0.35	V

Electrical Characteristics

V_{DD}=5V, GND=0V, T_A= 25°C (unless otherwise noted)

Symbol	Parameter	Test Conditions	APA2010B			Unit	
			Min.	Typ.	Max.		
I _{DD}	Supply Current		-	2	-	mA	
I _{SD}	Shutdown Current	$\overline{SD} = 0V$	-	1	-	μA	
I _i	Input current	\overline{SD}	-	0.1	-	μA	
F _{osc}	Oscillator Frequency		200	250	300	kHz	
R _{DSCON}	Static drain-source on-state resistance	V _{DD} = 5V	P-Channel MOSFET (WLCSP1.5X1.5-9A)	-	340	-	mΩ
			N-Channel MOSFET (WLCSP1.5X1.5-9A)	-	195	-	
		V _{DD} = 3.6V	P-Channel MOSFET (WLCSP1.5X1.5-9A)	-	400	-	
			N-Channel MOSFET (WLCSP1.5X1.5-9A)	-	215	-	
		V _{DD} = 2.4V	P-Channel MOSFET (WLCSP1.5X1.5-9A)	-	550	-	
			N-Channel MOSFET (WLCSP1.5X1.5-9A)	-	260	-	
V_{DD}=5V, T_A=25 °C							
P _O	Output Power	THD+N = 1%, f _{in} = 1kHz	R _L = 4Ω (WLCSP1.5X1.5-9A)	-	2.45	-	W
			R _L = 4Ω	-	2.1	-	
			R _L = 8Ω	1	1.3	-	
		THD+N = 10%, f _{in} = 1kHz	R _L = 4Ω (WLCSP1.5X1.5-9A)	-	3.1	-	
			R _L = 4Ω	-	2.65	-	
			R _L = 8Ω	-	1.6	-	
THD+N	Total Harmonic Distortion Pulse Noise	f _{in} = 1kHz	R _L = 4Ω P _O = 1.6W	-	0.3	-	%
			R _L = 8Ω P _O = 0.96W	-	0.1	-	
PSRR	Power Supply Rejection Ratio	R _L = 8Ω, f _{in} = 217Hz	-	80	-	dB	
V _{OS}	Output Offset Voltage	R _L = 8Ω			25	mV	
S/N		With A-weighting Filter P _O = 0.96W, R _L = 8Ω	-	90	-	dB	
V _n	Noise Output Voltage	With A-weighting Filter	-	100	-	μV (rms)	

Electrical Characteristics (Cont.)

V_{DD}=5V, GND=0V, T_A= 25°C (unless otherwise noted)

Symbol	Parameter	Test Conditions	APA2010B			Unit	
			Min.	Typ.	Max.		
V_{DD}=3.6V, T_A=25 C							
P _O	Output Power	THD+N = 1%, f _{in} = 1kHz	R _L = 4Ω (WLCSP1.5X1.5-9A)	-	1.2	-	W
			R _L = 4Ω	-	1.1	-	
			R _L = 8Ω	-	0.6	-	
		THD+N = 10%, f _{in} = 1kHz	R _L = 4Ω (WLCSP1.5X1.5-9A)	-	1.5	-	
			R _L = 4Ω	-	1.35	-	
			R _L = 8Ω	-	0.8	-	
THD+N	Total Harmonic Distortion Pulse Noise	f _{in} = 1kHz	R _L = 4Ω P _O = 0.82W,	-	0.35	-	%
			R _L = 8Ω P _O = 0.45W	-	0.1	-	
PSRR	Power Supply Rejection Ratio	R _L = 8Ω, f _{in} = 217Hz		-	75	-	dB
V _{OS}	Output Offset Voltage	R _L = 8Ω		-	-	25	mV
S/N		With A-weighting Filter P _O = 0.43W, R _L = 8Ω,		-	85	-	dB
V _n	Noise Output Voltage	With A-weighting Filter		-	105	-	μV (rms)
V_{DD}=2.5V, T_A=25 C							
P _O	Output Power	THD+N = 1%, f _{in} = 1kHz	R _L = 4Ω	-	0.45	-	W
			R _L = 8Ω	-	0.3	-	
		THD+N = 10%, f _{in} = 1kHz	R _L = 4Ω	-	0.55	-	
			R _L = 8Ω	-	0.35	-	
THD+N	Total Harmonic Distortion Pulse Noise	f _{in} = 1kHz	P _O = 0.34W, R _L = 4Ω	-	0.35	-	%
			P _O = 0.22W, R _L = 8Ω	-	0.2	-	
PSRR	Power Supply Rejection Ratio	R _L = 8Ω, f _{in} = 217Hz		-	70	-	dB
V _{OS}	Output Offset Voltage	R _L = 8Ω		-	-	25	mV
S/N		With A-weighting Filter P _O = 0.2W, R _L = 8Ω		-	83	-	dB
V _n	Noise Output Voltage	With A-weighting Filter		-	120	-	μV (rms)

Typical Operating Characteristics

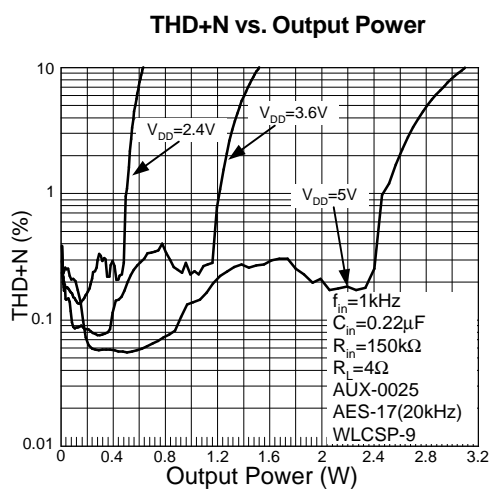
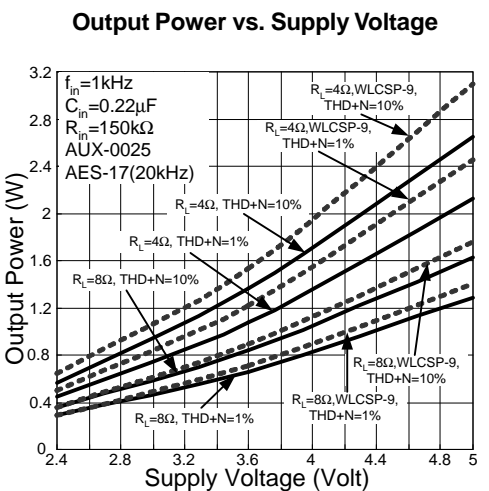
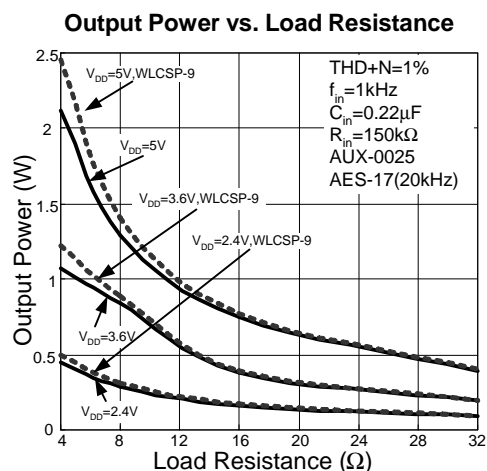
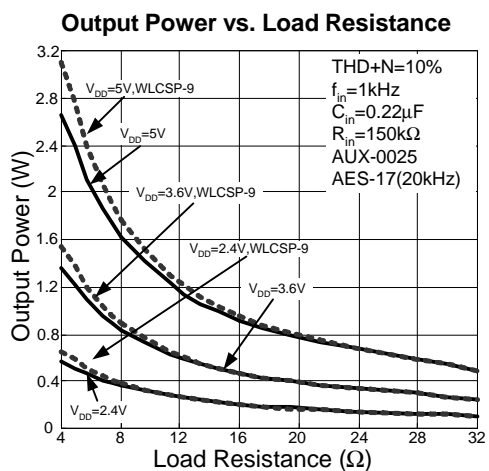
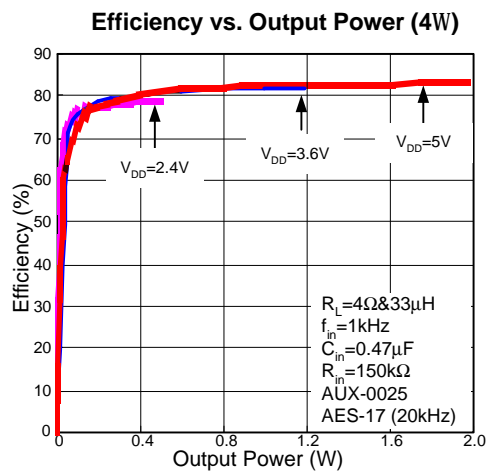
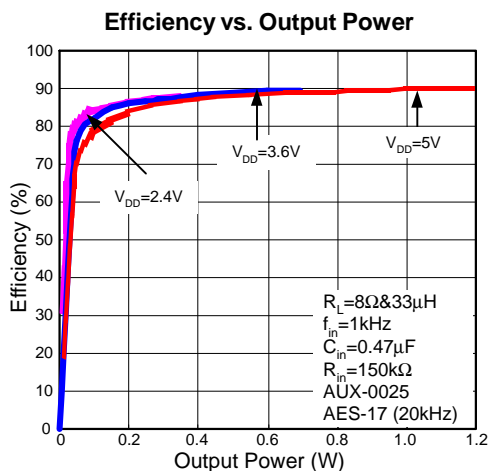

Typical Operating Characteristics (Cont.)

THD+N vs. Output Power

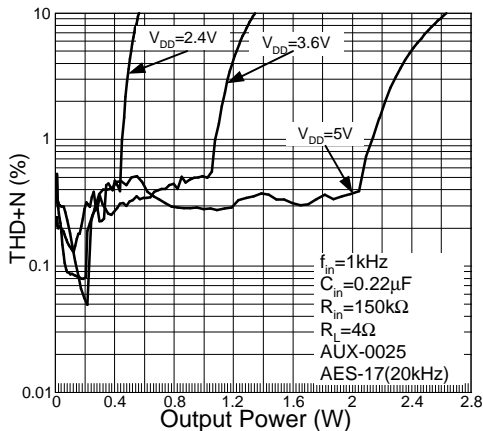

THD+N vs. Frequency

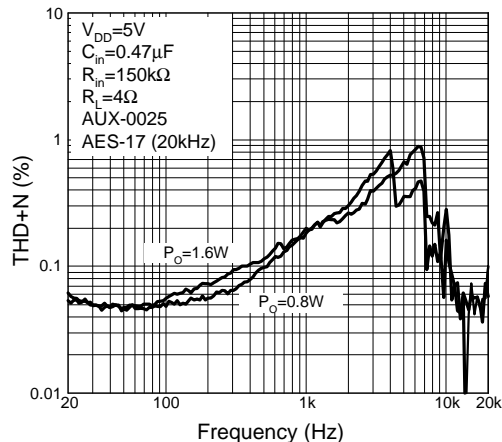

THD+N vs. Frequency

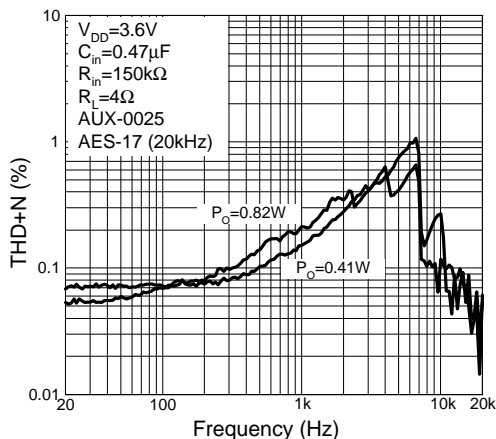

THD+N vs. Frequency

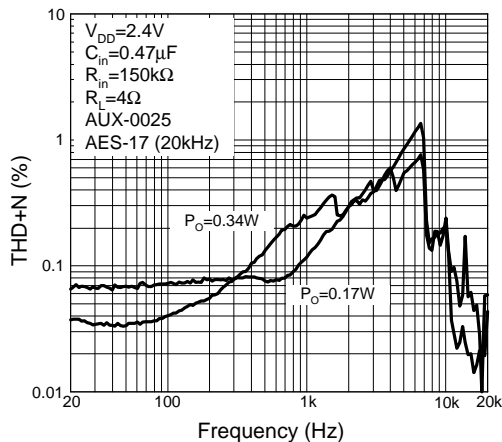

THD+N vs. Output Power

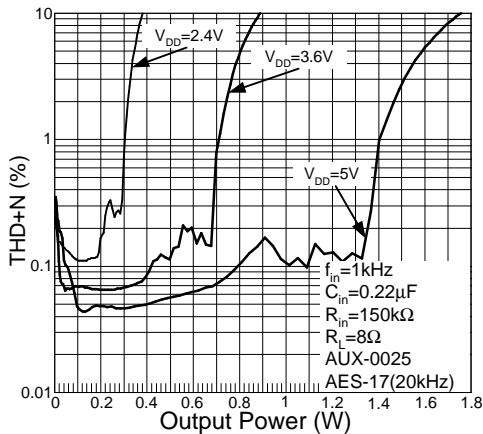

THD+N vs. Frequency

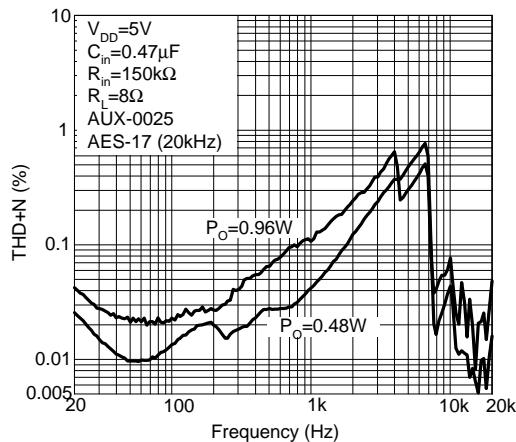

Typical Operating Characteristics (Cont.)

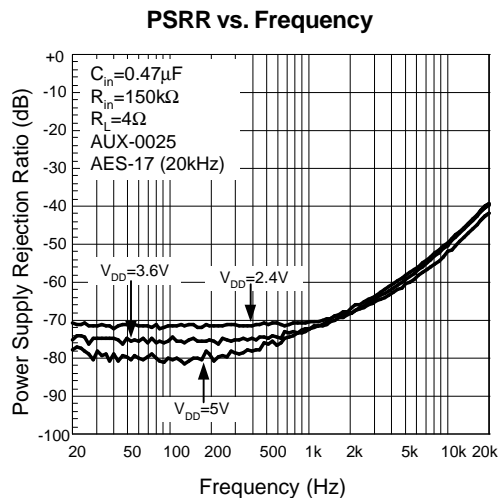
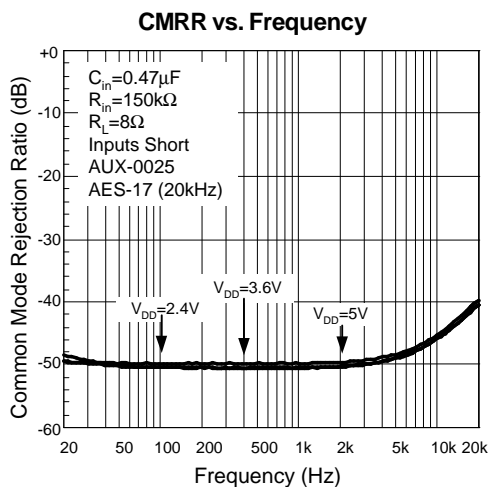
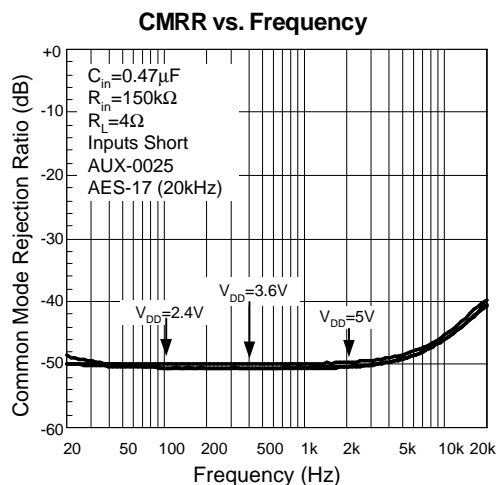
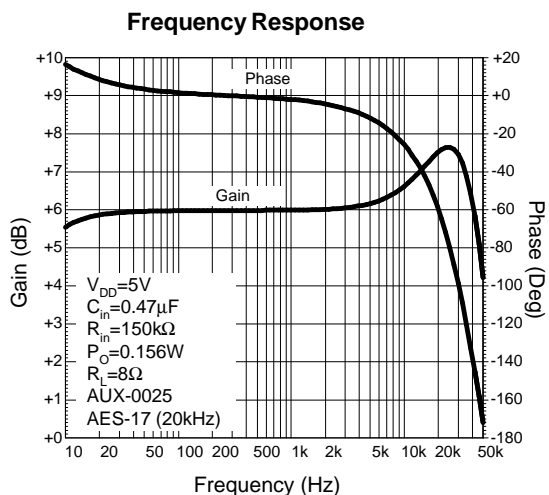
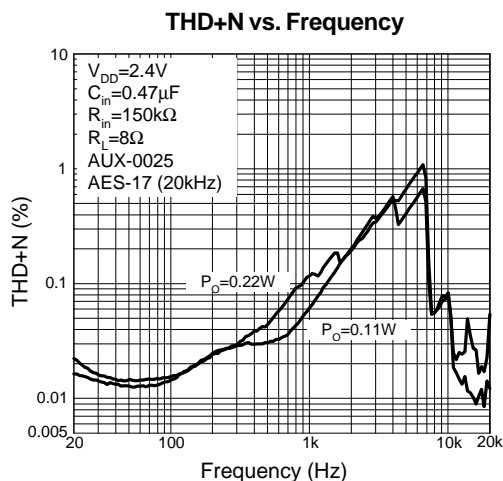
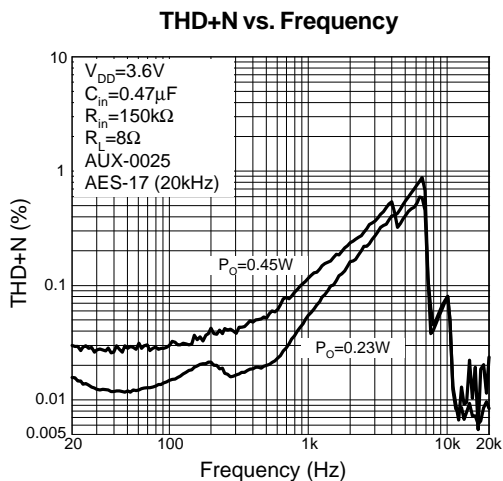

Typical Operating Characteristics (Cont.)

PSRR vs. Frequency

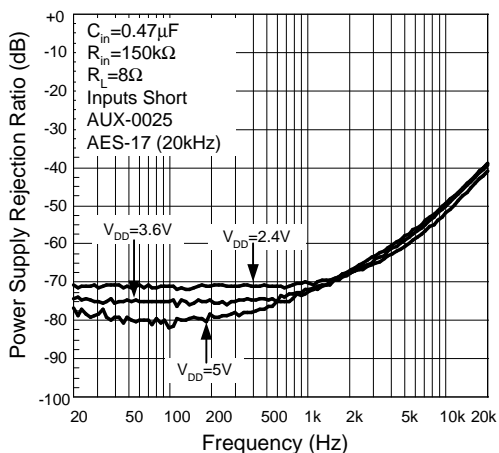

Output Noise Voltage vs. Frequency

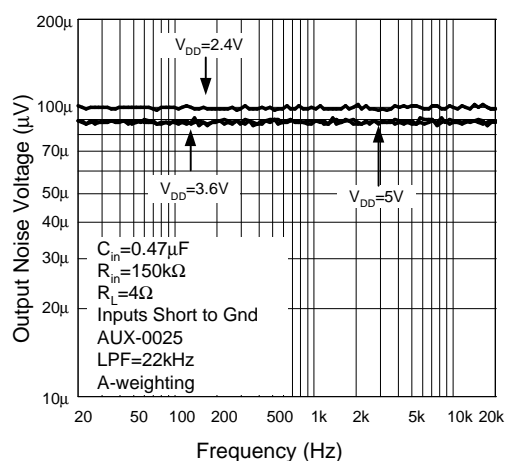

Output Noise Voltage vs. Frequency

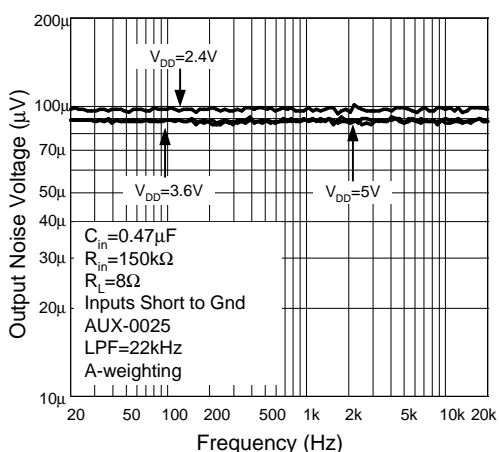

Supply Current vs. Output Power

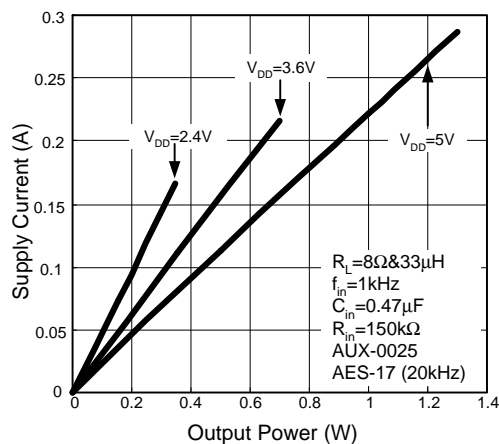

Supply Current vs. Output Power

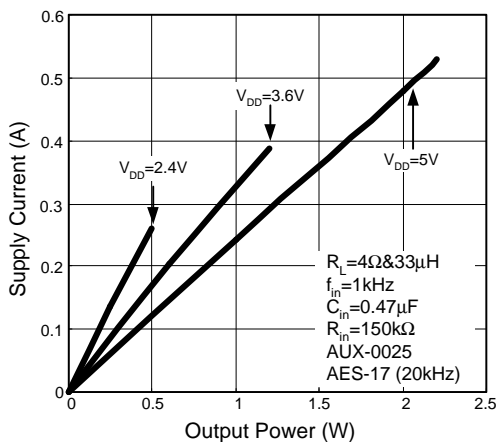

Supply Current vs. Supply Voltage

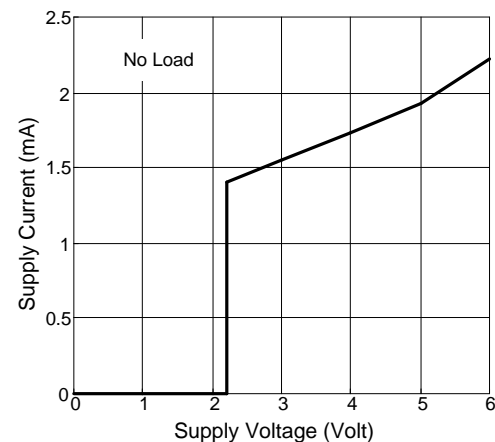

Typical Operating Characteristics (Cont.)

Shutdown Current vs. Supply Voltage

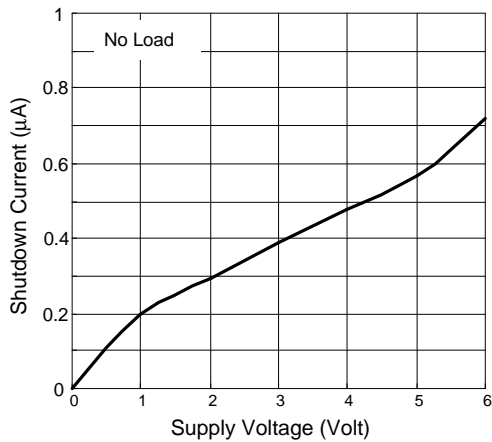

GSM Power Supply Rejection vs. Time

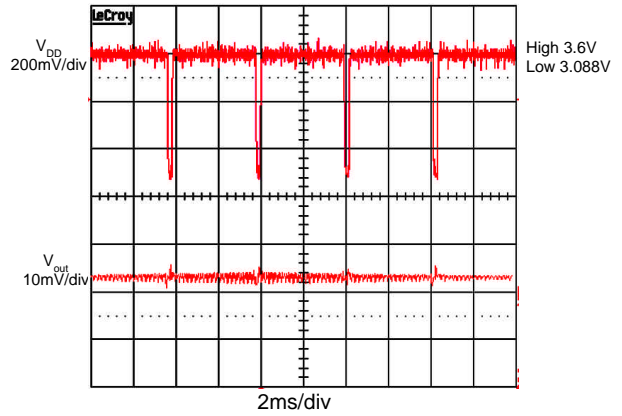

GSM Power Supply Rejection vs. Frequency

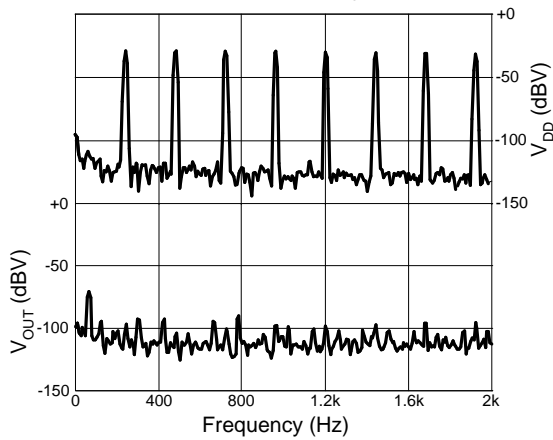

Common Mode Rejection ratio vs. Common Mode Input Voltage

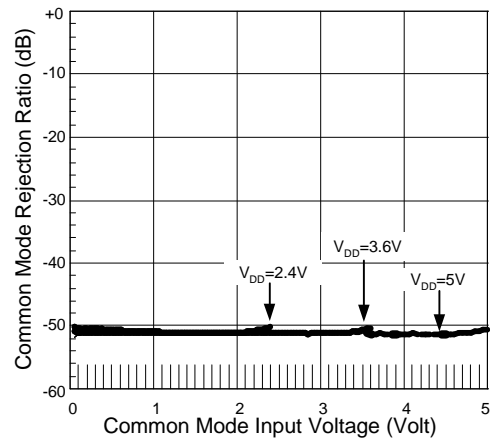

Pin Description

PIN (WLCSP1.5X1.5-9A)		I/O	FUNCTION
NO.	NAME		
A1	INP	I	The non-inverting input of amplifier. INP is connected to Gnd via a capacitor for single-end (SE) input signal.
A2	GND	-	Ground connection for circuitry.
A3	VON	O	The negative output terminal of Class-D amplifier.
B1	VDD	-	Supply voltage input pin.
B2	PVDD	-	Supply voltage only for power stage.
B3	PGND	-	Ground connection for power stage
C1	INN	I	The inverting input of amplifier. INN is used as audio input terminal, typically.
C2	\overline{SD}	I	Shutdown mode control signal input, place entire IC in shutdown mode when held low.
C3	VOP	O	The positive output terminal of Class-D amplifier.

Block Diagram

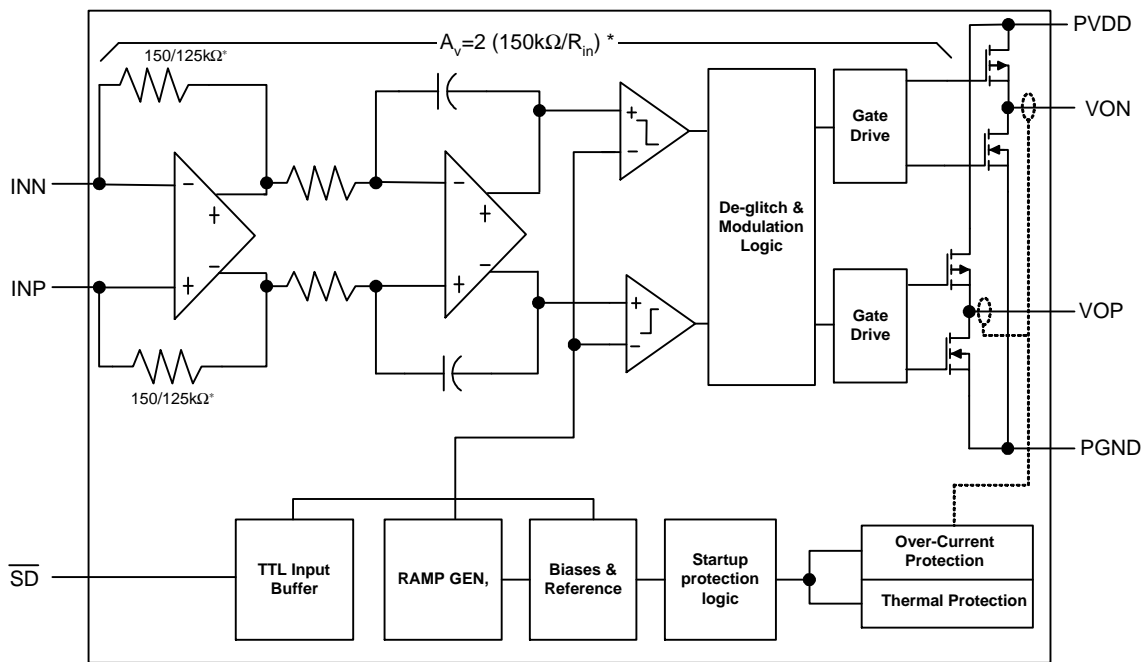

* APA2010B : 150kΩ

Typical Application Circuit

Differential input mode (WLCSP1.5x1.5-9A)

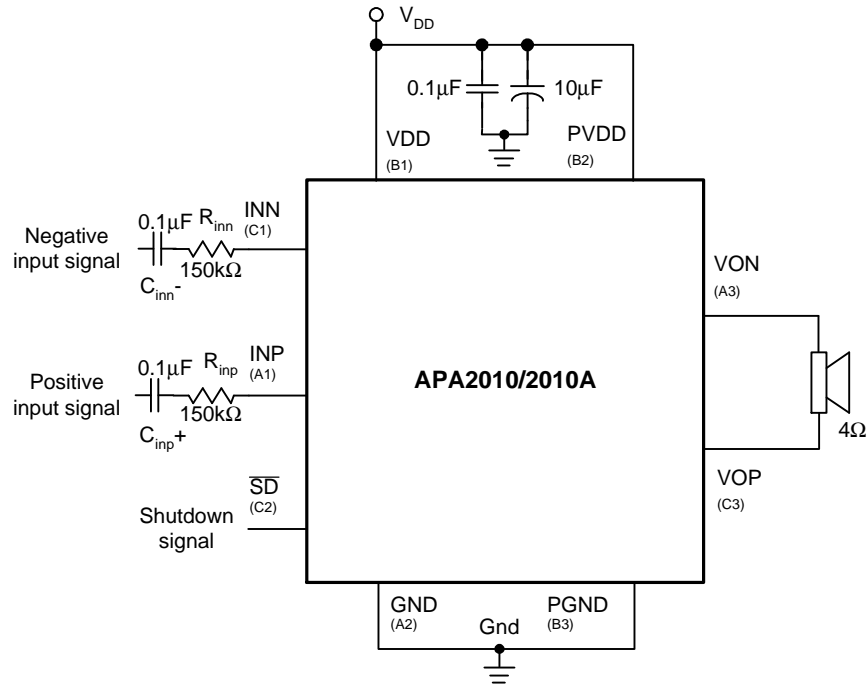

Single-ended input mode (WLCSP1.5x1.5-9A)

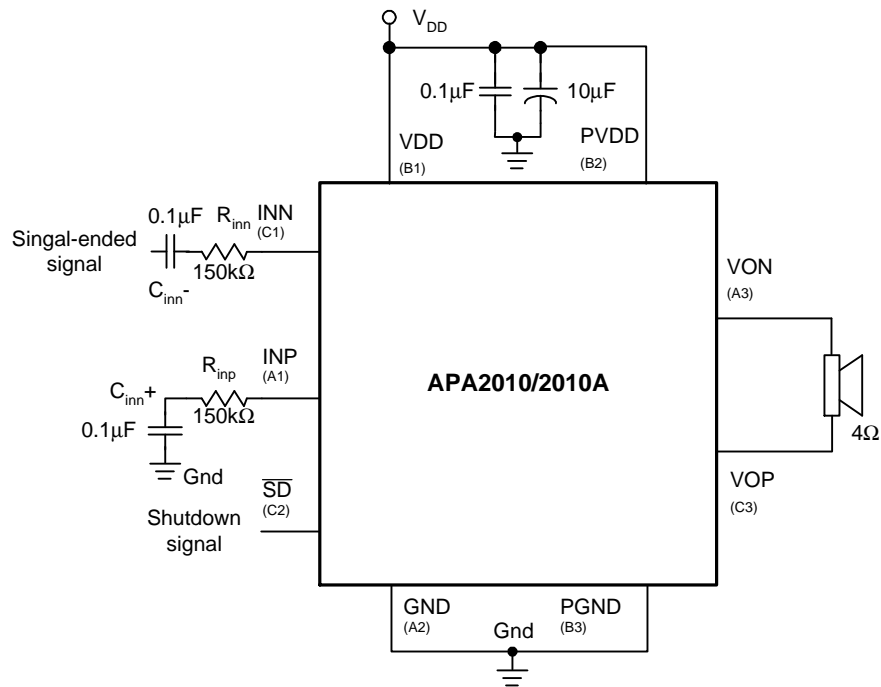

Application Information

Fully Differential Amplifier

The APA2010B is a fully distinctive amplifier with differential inputs and outputs. Compare with the traditional amplifiers, the fully differential amplifier has some advantages. Firstly, there is no need for the input coupling capacitors because the common-mode feedback will compensate the input bias. The inputs can be biased from 0.5V to $V_{DD}-0.5V$, and the outputs still be biased at mid-supply of APA2010B. If the inputs are biased out of the input range, the coupling capacitors are required. Secondly, there is no need for the mid-supply capacitor (C_B) either because any shift of the mid-supply of APA2010B will have the same affection on both positive & negative channel, and will cancel at the differential outputs. Thirdly, the fully differential amplifier will cancel the GSM RF transmitter's signal (217Hz).

Class-D Operation

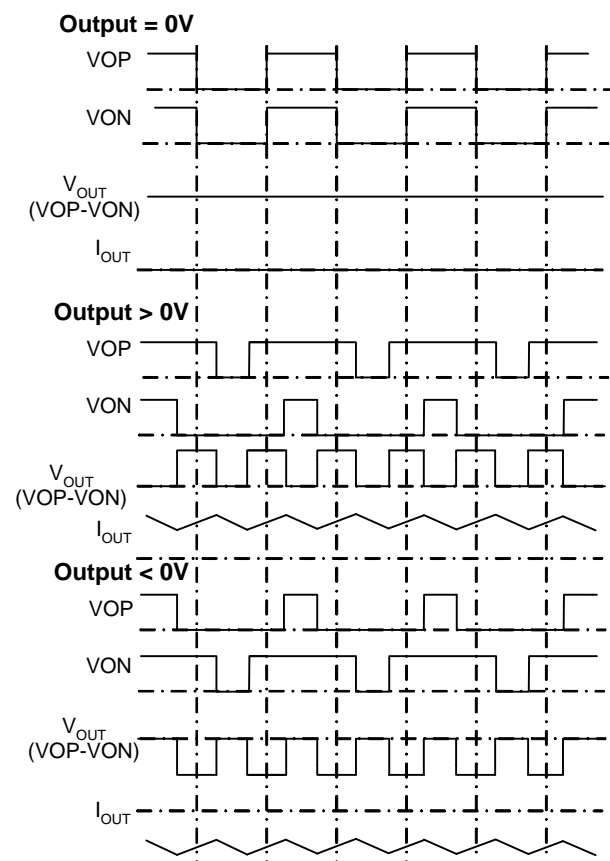

Figure 1. The Class-D Power Amplifier Output Waveform (Voltage & Current)

The APA2010B modulation scheme is shown in figure 1. The outputs VOP and VON are in phase with each other when no input signals. When output $> 0V$, the duty cycle of VOP is greater than 50% and VON is less than 50%; on the contrary, when output $< 0V$, the duty cycle of VOP is less than 50% and VON is greater than 50%. This method reduces the switching current across the load and the I^2R losses in the load which can improve the amplifier's efficiency.

This modulation scheme has very short pulses across the load which results in the small ripple current and very little loss on the load. Meanwhile, the LC filter can be eliminated in most applications. Adding the LC filter can increase the efficiency by filtering the ripple current.

Square Wave Into the Speaker

Applying the square wave into the speaker may cause the voice coil of speaker jumping out the air gap and defacing the voice coil. However, this depends on if the amplitude of square wave is high enough and the bandwidth of speaker is higher than the square wave's frequency. For 250kHz switching frequency, this is not an issue for the speaker because the frequency is beyond the audio band and can't significantly move the voice coil, as cone movement is proportional to $1/f^2$ for frequency out of audio band.

Input Resistance, R_{in}

The gain of the APA2010B has been set by the external resistors (R_{in}).

$$\text{Gain}(A_v) = \frac{2 \times 150k\Omega \text{ (or } 125k\Omega)}{R_{in}} \quad (1)$$

For fully differential operating, the R_{in} match is very important for CMRR, PSRR and harmonic distortion performance. It's recommended to use 1% tolerance resistor or better. Keeping the input trace as short as possible to limit the noise injection.

The gain is recommended to set as 2V/V or lower for APA2010B's optimal performance.

Input Capacitor, C_{in}

In the typical application, an input capacitor, C_{in} , is required to allow the amplifier to bias the input signal to the proper DC level for optimum operation. In this case, C_{in} and the

Application Information (Cont.)

Input Capacitor, C_i (Cont.)

minimum input impedance R_{in} from a high-pass filter with the corner frequency are determined in the following equation:

$$F_{C(\text{highpass})} = \frac{1}{2\pi R_{in} C_{in}} \quad (2)$$

The value of C_{in} must be considered carefully because it directly affects the low frequency performance of the circuit. For example, when R_{in} is 150k Ω and the specification calls for a flat bass response are down to 20Hz. The equation is reconfigured as below:

$$C_{in} = \frac{1}{2\pi R_{in} F_c} \quad (3)$$

When input resistance is considered, the C_{in} is 0.05 μ F. Therefore, a value in the range of 0.068 μ F to 0.1 μ F would be chosen. A further consideration for this capacitor is the leakage path from the input source through the input network ($R_{in} + R_f, C_{in}$) to the load.

This leakage current creates a DC offset voltage at the input to the amplifier that reduces useful headroom, especially in high gain applications. For this reason, a low-leakage tantalum or ceramic capacitor is the best choice. When polarized capacitors are used, the positive side of the capacitor should face the amplifier input in most applications because the DC level of the amplifiers' inputs are held at $V_{DD}/2$. Please note that it is important to confirm the capacitor polarity in the application.

Output Capacitor, C_o

If the user wants to add capacitor at output without ferrite bead and inductor, please note the output capacitor should not be greater than 1nf ($V_{DD}=4.2V$). The high value of output capacitor maybe trigger the OCP (Over-Current Protection) of APA2010B.

Power Supply Decoupling, C_s

The APA2010B is a high-performance CMOS audio amplifier that requires adequate power supply decoupling to ensure the output total harmonic distortion (THD+N) is as low as possible. Power supply decoupling also prevents the oscillations being caused by long lead length between the amplifier and the speaker.

The optimum decoupling is achieved by using two differ-

ent types of capacitors that target on different types of noise on the power supply leads. For higher frequency transients, spikes, or digital hash on the line, a good low equivalent-series-resistance (ESR) ceramic capacitor, typically 0.1 μ F, is placed as close as possible to the device VDD pin for the best operation. For filtering lower frequency noise signals, a large aluminum electrolytic capacitor of 10 μ F or greater is placed near the audio power amplifier is recommended.

Shutdown Function

In order to reduce power consumption while not in use, the APA2010B contains a shutdown function to externally turn off the amplifier bias circuitry. This shutdown feature turns the amplifier off when logic low is placed on the \overline{SD} pin for APA2010B. The trigger point between a logic high and logic low level is typically 0.4VDD. It suggests to switch to either ground or the supply voltage VDD to provide maximum device performance. By switching the \overline{SD} pin to a low level, the amplifier enters a low-consumption-current state, and then the APA2010B is in shutdown mode. In normal operating, APA2010B's \overline{SD} pin should be pulled to a high level to keep the IC out of the shutdown mode. The \overline{SD} pin should be tied to a definite voltage to avoid unwanted state changes.

Output LC Filter

If the traces from the APA2010B to speaker are short, the APA2010B doesn't require output filter for FCC & CE standard.

A ferrite bead may be needed if it's failing the test for FCC or CE is tested without the LC filter. The Figure 2 is the sample for adding ferrite bead; the ferrite shows when choosing high impedance in high frequency.

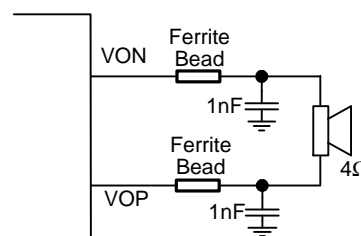

Figure 2. Ferrite bead output filter

Application Information (Cont.)

Output LC Filter (Cont.)

Figure 3 is an example for adding the LC filter. It's recommended to eliminate the radiated emission or EMI when the trace from amplifier to speaker is too long.

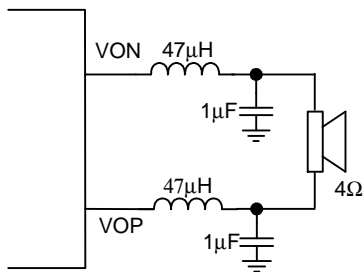

Figure 3. LC output filter

Figure 3's low pass filter cut-off frequency is F_c

$$F_{C(\text{lowpass})} = \frac{1}{2\pi\sqrt{LC}} \quad (4)$$

Mixing Two Single-Ended Input Signals

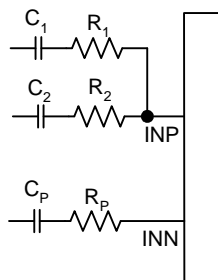

Figure 4. Mixing Two Single-Ended Input Signals

For mixing two Single-Ended (SE) input signals, please refer to Figure 4. The gains of each input can be set difference:

$$A_V(1) = \frac{2 \times 150\text{k}\Omega \text{ (or } 125\text{k}\Omega)}{R_1} \quad (5)$$

$$A_V(2) = \frac{2 \times 150\text{k}\Omega \text{ (or } 125\text{k}\Omega)}{R_2} \quad (6)$$

The corner frequency of each input high-pass-filter also can be set by $R_1 \& C_1$, and $R_2 \& C_2$.

The non-inverting input's resistor (R_p) and capacitor (C_p) need to match the impedances of invert inputs.

$$C_p = C_1 // C_2 = C_1 + C_2 \quad (7)$$

$$R_p = R_1 // R_2 = \frac{R_1 \times R_2}{R_1 + R_2} \quad (8)$$

Layout Recommendation

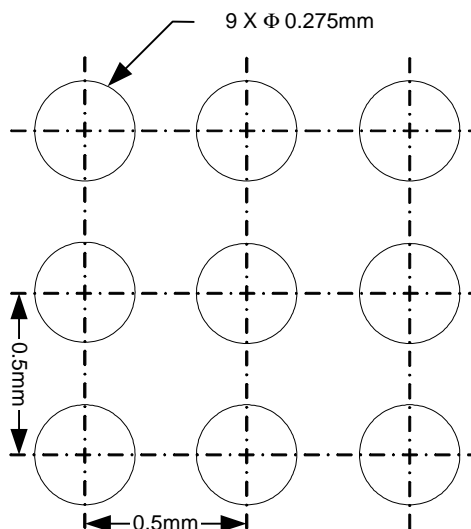
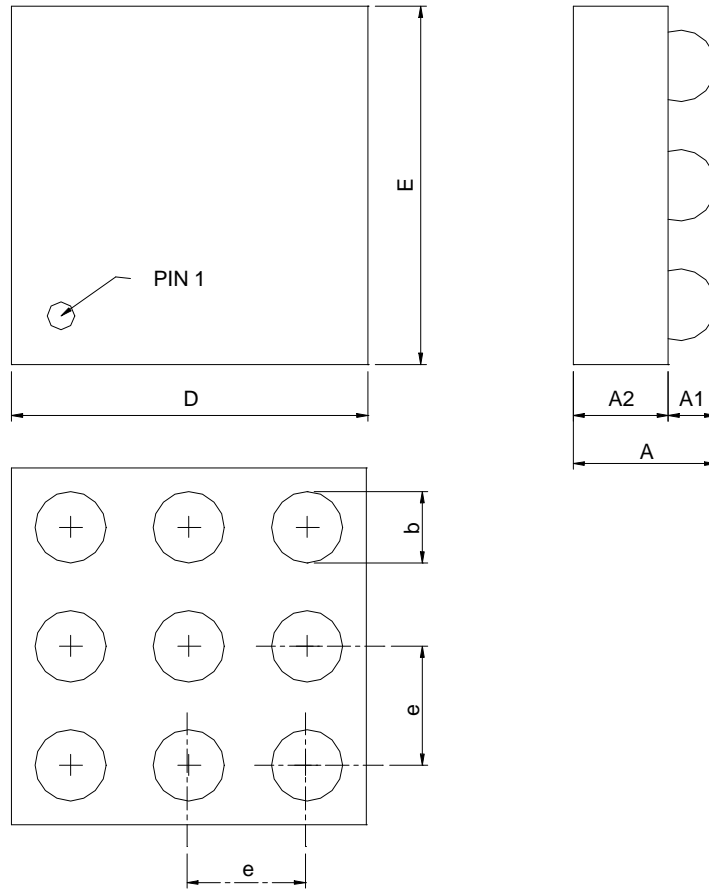

Figure 5. WLCSP-9 land pattern recommendation

1. All components should be placed close to the APA2010B. For example, the input resistor (R_m) should be close to APA2010B's input pins to avoid causing noise coupling to APA2010B's high impedance inputs; the decoupling capacitor (C_s) should be placed by the APA2010B's power pin to decouple the power rail noise.
2. The output traces should be short, wide (>50mil), and symmetric.
3. The input trace should be short and symmetric.
4. The power trace width should greater than 50mil.

Package Information

WLCSP1.5x1.5-9A



SYMBOL	WLCSP1.5x1.5-9A			
	MILLIMETERS		INCHES	
	MIN.	MAX.	MIN.	MAX.
A	0.53	0.67	0.021	0.026
A1	0.20	0.24	0.008	0.009
A2	0.33	0.43	0.013	0.017
b	0.29	0.31	0.011	0.012
D	1.42	1.50	0.056	0.059
E	1.42	1.50	0.056	0.059
e	0.50 BSC		0.020 BSC	

Carrier Tape & Reel Dimensions

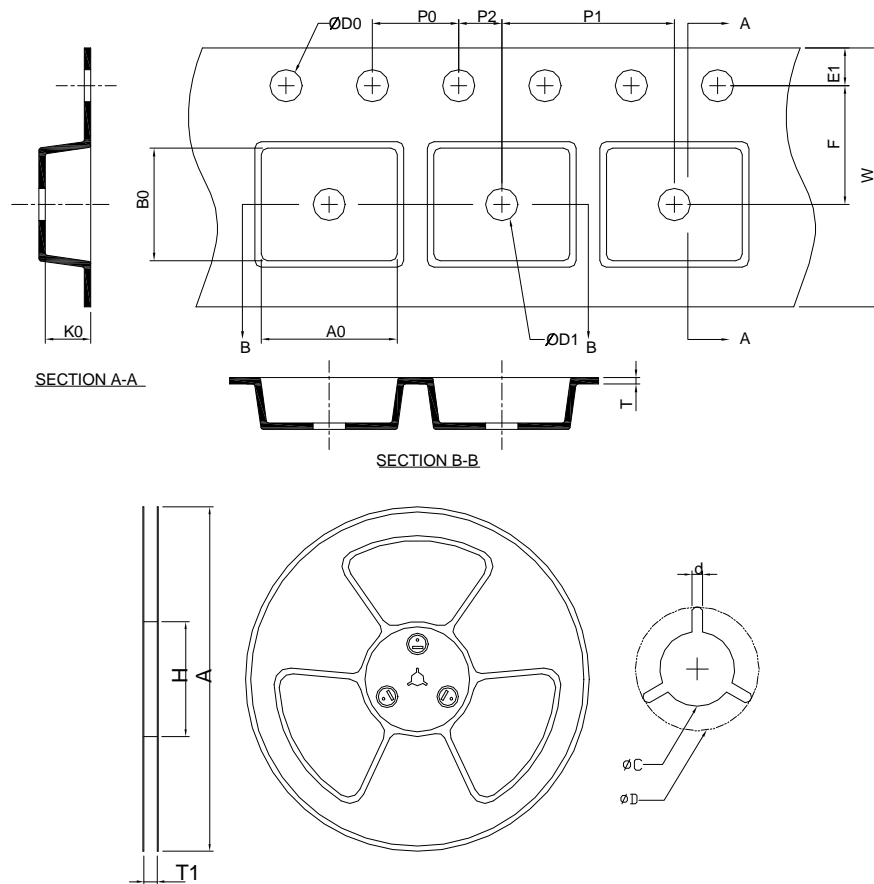

Application	A	H	T1	C	d	D	W	E1	F
WLCSP1.5X1.5-9A	178.0 ±2.00	50 MIN.	8.4+2.00 -0.00	13.0+0.50 -0.20	1.5 MIN.	20.2 MIN.	8.0 ±0.30	1.75 ±0.10	3.5 ±0.05
	P0	P1	P2	D0	D1	T	A0	B0	K0
	4.0 ±0.10	4.0 ±0.10	2.0 ±0.05	1.5+0.10 -0.00	1.5 MIN.	0.6+0.00 -0.40	1.70 ±0.20	1.70 ±0.20	0.90 ±0.20

(mm)

Devices Per Unit

Package Type	Unit	Quantity
WLCSP1.5X1.5-9A	Tape & Reel	3000

Taping Direction Information

WLCSP1.5x1.5-9A

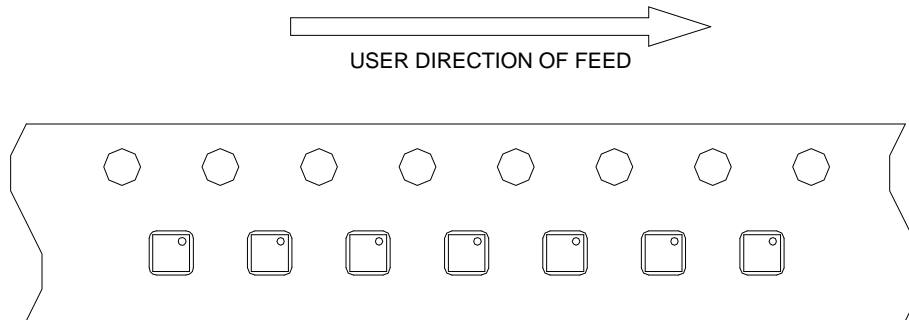

Classification Profile

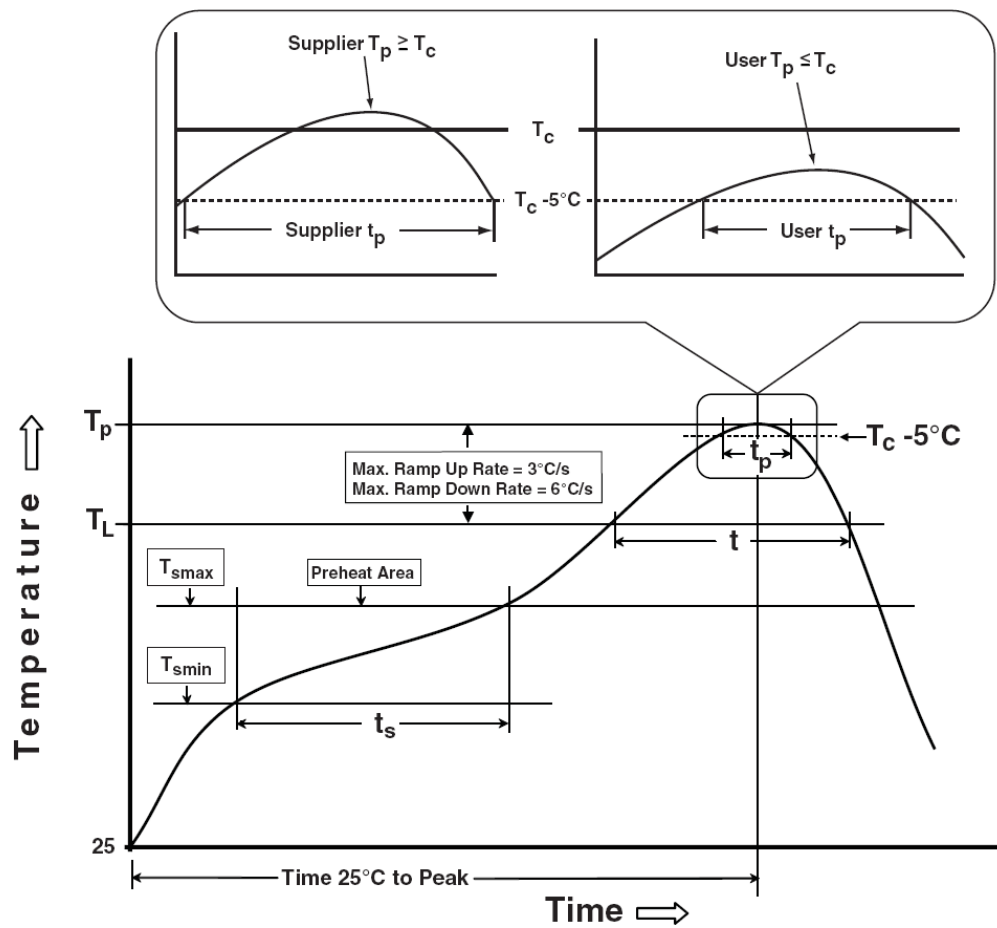

Classification Reflow Profiles

Profile Feature	Sn-Pb Eutectic Assembly	Pb-Free Assembly
Preheat & Soak		
Temperature min (T_{smin})	100 °C	150 °C
Temperature max (T_{smax})	150 °C	200 °C
Time (T_{smin} to T_{smax}) (t_s)	60-120 seconds	60-120 seconds
Average ramp-up rate (T_{smax} to T_p)	3 °C/second max.	3°C/second max.
Liquidous temperature (T_L)	183 °C	217 °C
Time at liquidous (t_L)	60-150 seconds	60-150 seconds
Peak package body Temperature (T_p)*	See Classification Temp in table 1	See Classification Temp in table 2
Time (t_p)** within 5°C of the specified classification temperature (T_c)	20** seconds	30** seconds
Average ramp-down rate (T_p to T_{smax})	6 °C/second max.	6 °C/second max.
Time 25°C to peak temperature	6 minutes max.	8 minutes max.
* Tolerance for peak profile Temperature (T_p) is defined as a supplier minimum and a user maximum.		
** Tolerance for time at peak profile temperature (t_p) is defined as a supplier minimum and a user maximum.		

Classification Reflow Profiles (Cont.)

Table 1. SnPb Eutectic Process – Classification Temperatures (T_c)

Package Thickness	Volume mm ³ <350	Volume mm ³ ≥350
<2.5 mm	235 °C	220 °C
≥2.5 mm	220 °C	220 °C

Table 2. Pb-free Process – Classification Temperatures (T_c)

Package Thickness	Volume mm ³ <350	Volume mm ³ 350-2000	Volume mm ³ >2000
<1.6 mm	260 °C	260 °C	260 °C
1.6 mm – 2.5 mm	260 °C	250 °C	245 °C
≥2.5 mm	250 °C	245 °C	245 °C

Reliability Test Program

Test item	Method	Description
SOLDERABILITY	JESD-22, B102	5 Sec, 245°C
HOLT	JESD-22, A108	1000 Hrs, Bias @ $T_j=125^\circ\text{C}$
PCT	JESD-22, A102	168 Hrs, 100%RH, 2atm, 121°C
TCT	JESD-22, A104	500 Cycles, -65°C~150°C
HBM	MIL-STD-883-3015.7	VHBM 2KV
MM	JESD-22, A115	VMM 200V
Latch-Up	JESD 78	10ms, 1 _{tr} 100mA

Customer Service

Anpec Electronics Corp.

Head Office :

No.6, Dusing 1st Road, SBIP,
Hsin-Chu, Taiwan
Tel : 886-3-5642000
Fax : 886-3-5642050

Taipei Branch :

2F, No. 11, Lane 218, Sec 2 Jhongsing Rd.,
Sindian City, Taipei County 23146, Taiwan
Tel : 886-2-2910-3838
Fax : 886-2-2917-3838